



**SUREClose®**

**Hydraulic Gate Closers & Hinges**



**NEW** External mount

Internal mount



**Internal or External mount...  
the choice is yours.**



**D&D Technologies**  
World's most trusted gate hardware



# SUREClose® READYFit

Externally Mounted

SureClose® is a hinge & closer, in one small, powerful package!



**Quick-fit alignment legs:**  
For ease of installation, alignment and two face fixing strength.

**Vertical alignment slots**  
Fasteners included

**Multiple adjustment options :**

- Self-closing speed and force
- Final snap-close action
- Horizontal adjustment

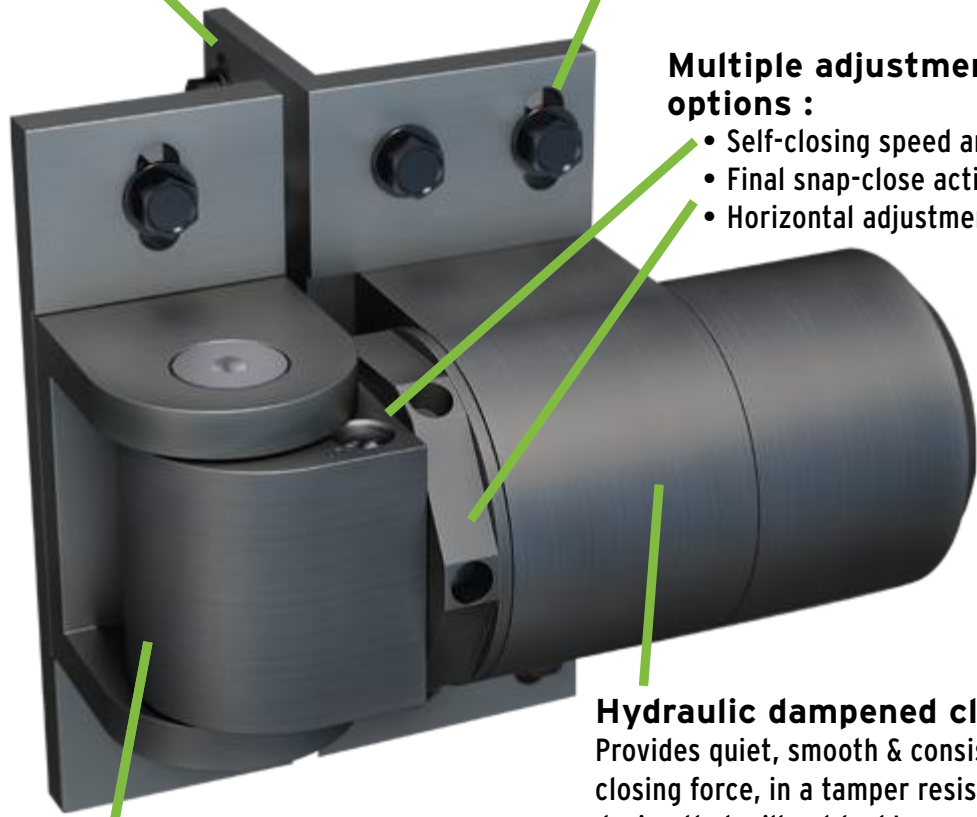

**Hydraulic dampened closing**  
Provides quiet, smooth & consistent closing force, in a tamper resistant design that will not leak!

**Dual bearing glide system™**  
Two rows of bearings for consistently superior performance.



**SureClose ReadyFit Hinge/Closer**



**ADJUSTABLE SELF-CLOSING SPEED AND FINAL SNAP-CLOSE ACTION**

**SureClose ReadyFit Hinge**



**NON SELF-CLOSING LOAD BEARING**

- Easy install - No special tools or holes in post
- Gap variance of 1/2" to 1 3/8" (12-35mm)
- All mounting brackets and fasteners included
- Quick alignment legs
- Safety gate models available
- Improved snap action (all 108 models)
- New non-removable adjustment nozzles
- Designed for new and existing gates

Hinge Combinations	Self-Closing Gate Weight Max*
108 + SM	180 lbs (80 kgs)
108 + 108	260 lbs (120 kgs)

Access Control	Weight Capacity
SM + SM	1,500 lbs (680 kgs)

\*CAUTION: Based on max gate size 72"H x 40"W (1800x1000mm). For gates with greater HxW, or if conditions such as wind play a role, use hinge combinations with higher self-closing weight ratings.

## GATE FUNCTION

- Hold-open  
Not for safety gates
- Self-closing  
Speed adjustable
- Final snap-close action  
For electric/coded locks
- Free-swinging

**ReadyFit Brackets**

Models	Bracket Material
74108315	Steel
74108313	Aluminum

**SELF-CLOSING - NON SAFETY**  
Not suitable for child/pool safety

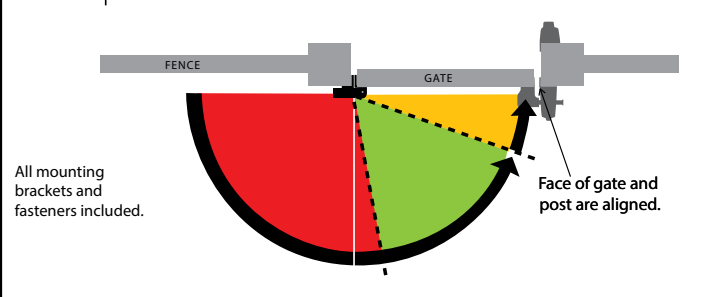

**ReadyFit Brackets**

Models	Bracket Material
74108325	Steel
74108323	Aluminum

**SELF-CLOSING - SAFETY (SF Model)**  
Suitable for child/pool safety\*  
DO NOT PROP GATE OPEN

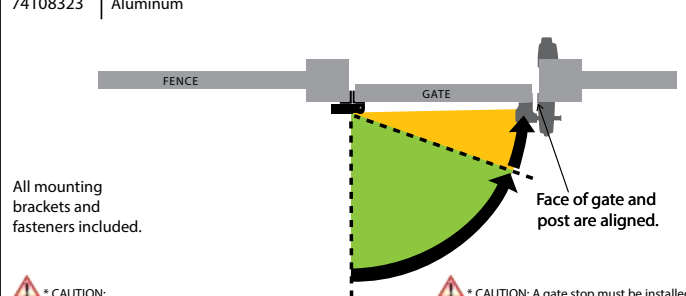

\* CAUTION: When used on swimming pool gates, always consult local authorities for swimming pool Codes.

\* CAUTION: A gate stop must be installed when using SF models. Gate must not be allowed to open past 90°. Doing so voids warranty.

**ReadyFit Brackets**

Models	Bracket Material
74001315	Steel
74001313	Aluminum

**NON SELF-CLOSING**  
Not suitable for child/pool safety

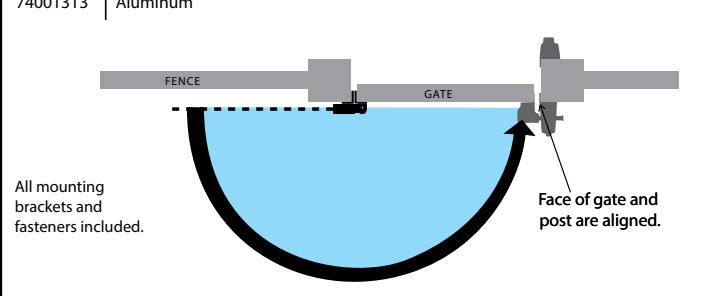

Item*	Type	Description	Self-Closing From	Max Gate Swing	Final Snap Action	Pool/Child Safety**	Hinge Gap	Fence Post Size Min.	Weight (Lbs)
74001313	RF SM S	ReadyFit Heavy Duty Hinge - Aluminum Brackets	-	180°	-	-	1/2" - 1-3/8"	2"+	2.10
74001315	RF SM W	ReadyFit Heavy Duty Hinge - Steel Brackets	-	180°	-	-	1/2" - 1-3/8"	2"+	2.93
74108313	RF 108 S	ReadyFit Heavy Duty Hinge/Closer - Aluminum Brackets	85°	180°	Yes	-	1/2" - 1-3/8"	2"+	2.91
74108315	RF 108 W	ReadyFit Heavy Duty Hinge/Closer - Steel Brackets	85°	180°	Yes	-	1/2" - 1-3/8"	2"+	3.74
74108323	RF 108SF S	ReadyFit Heavy Duty Hinge/Closer - SF - Aluminum Brackets	90°	90°	Yes	Yes	1/2" - 1-3/8"	2"+	2.91
74108325	RF 108SF W	ReadyFit Heavy Duty Hinge/Closer - SF - Steel Brackets	90°	90°	Yes	Yes	1/2" - 1-3/8"	2"+	3.74

\*All ReadyFit hinges include fasteners, gate and post mounting brackets.

\*\*Yes (SF) = Gate will not hold open at 90° (OK for safety gates). Do NOT use a hinge with a 90° hold open feature (-) for pool / child safety gates.

IMPORTANT: For maximum gate weights, see weight chart above.

CAUTION: A gate stop must be installed when using SF models. Gate must not be allowed to open past 90°. Doing so voids warranty.



# SUREClose®

## Internal Post Mounting

**SureClose® is a hinge & closer, in one small, powerful package!**

### Mounting Brackets :

A variety of gate brackets allow for virtually any square-post application:

- Steel or Aluminum
- Fastened or Welded
- Flush mount or center mount

### Multiple Adjustment Options :

- Self-closing speed and force
- Final snap-close action - Now 30% Stronger
- Horizontal adjustment with Center Mount Bracket

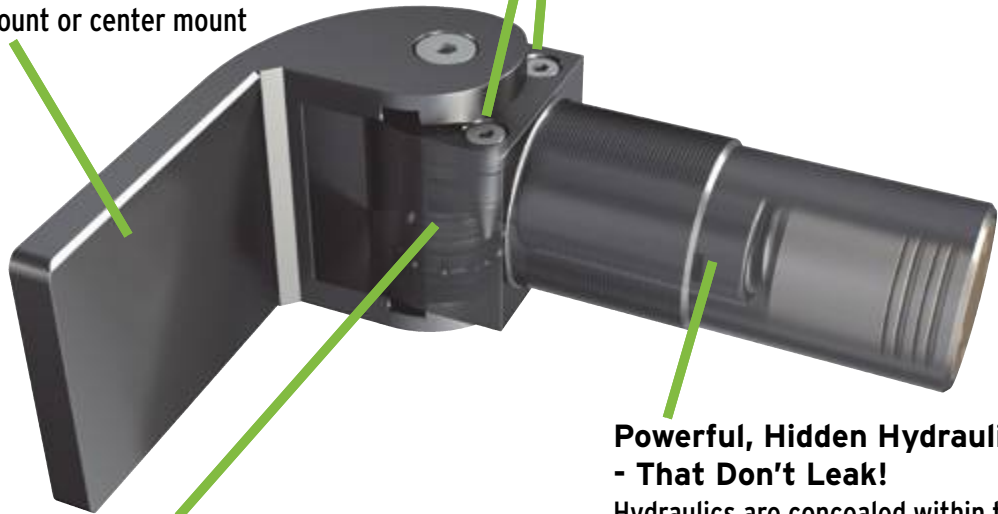

**Dual Bearing Glide System™:**  
Two rows of bearings for consistently superior performance.

### Powerful, Hidden Hydraulics - That Don't Leak!

Hydraulics are concealed within the post, providing a controlled, quiet close, in a tamper-resistant, compact design.

- Maintenance free
- Flush mount & center mount options
- Non self-closing models available
- Visibly small footprint
- Multiple adjustment options
- Prevents gate slam noise & gate damage
- Self-closes gates up to 260 lbs.
- High corrosion resistance  
-50 Micron anodizing (Aluminum Components)



Hinge Combinations	Self-Closing Gate Weight Max*
57 + SM	90 lbs (40 kgs)
57 + 57	180 lbs (80 kgs)
108 + SM	180 lbs (80 kgs)
108 + 108	260 lbs (120 kgs)

Access Control	Weight Capacity
SM + SM	1,500 lbs (680 kgs)

\*CAUTION: Based on max gate size 72"H x 40"W (1800x1000mm). For gates with greater HxW, or if conditions such as wind play a role, use hinge combinations with higher self-closing weight ratings.

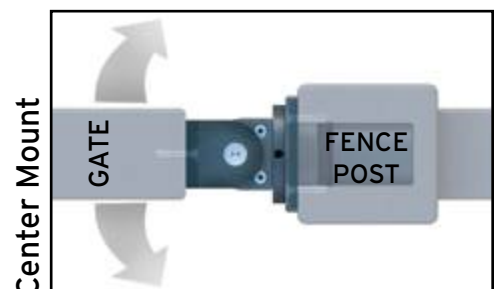
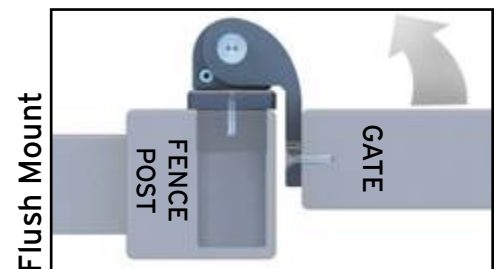

# GATE FUNCTION

- Hold-open  
Not for safety gates
- Final snap-close action  
For electric/coded locks
- Self-closing  
Speed adjustable
- Free-swinging

<p><b>Flush Mount Brackets</b></p> <table border="1" style="width: 100%; border-collapse: collapse;"> <thead> <tr> <th>Models</th> <th>Bracket Material</th> </tr> </thead> <tbody> <tr> <td>75108214</td> <td>Steel</td> </tr> <tr> <td>75108213</td> <td>Aluminum</td> </tr> </tbody> </table> <p><b>SELF-CLOSING - NON SAFETY</b> Not suitable for child/pool safety</p> <p>Use post bracket: 7525 Steel 7515 Aluminum</p> <p>Flush Mount: Face of gate and post are aligned.</p>	Models	Bracket Material	75108214	Steel	75108213	Aluminum	<p><b>Flush Mount Brackets</b></p> <table border="1" style="width: 100%; border-collapse: collapse;"> <thead> <tr> <th>Models</th> <th>Bracket Material</th> </tr> </thead> <tbody> <tr> <td>75108224</td> <td>Steel</td> </tr> <tr> <td>75108223</td> <td>Aluminum</td> </tr> </tbody> </table> <p><b>SELF-CLOSING - SAFETY (SF Model)</b> Suitable for child/pool safety* DO NOT PROP GATE OPEN</p> <p>Use post bracket: 7525 (W) 7515 Aluminum</p> <p>Flush Mount: Face of gate and post are aligned.</p> <p><small>* CAUTION: When used on swimming pool gates, always consult local authorities for swimming pool Codes.</small></p>	Models	Bracket Material	75108224	Steel	75108223	Aluminum
Models	Bracket Material												
75108214	Steel												
75108213	Aluminum												
Models	Bracket Material												
75108224	Steel												
75108223	Aluminum												
<p><b>Center Mount Brackets</b></p> <table border="1" style="width: 100%; border-collapse: collapse;"> <thead> <tr> <th>Models</th> <th>Bracket Material</th> </tr> </thead> <tbody> <tr> <td>75108114</td> <td>Steel</td> </tr> <tr> <td>75108113</td> <td>Aluminum</td> </tr> </tbody> </table> <p><b>SELF-CLOSING - NON SAFETY</b> Not suitable for child/pool safety</p> <p>Use post bracket: 7526 Steel 7511 Aluminum 7512 Aluminum 7513 Aluminum 7514 Aluminum</p> <p>Center Mount: Center of gate and post are aligned.</p>	Models	Bracket Material	75108114	Steel	75108113	Aluminum	<p><b>Center Mount Brackets</b></p> <table border="1" style="width: 100%; border-collapse: collapse;"> <thead> <tr> <th>Models</th> <th>Bracket Material</th> </tr> </thead> <tbody> <tr> <td>75108124</td> <td>Steel</td> </tr> <tr> <td>75108123</td> <td>Aluminum</td> </tr> </tbody> </table> <p><b>SELF-CLOSING - SAFETY (SF Model)</b> Suitable for child/pool safety* DO NOT PROP GATE OPEN</p> <p>Use post bracket: 7526 Steel 7511 Aluminum 7512 Aluminum 7513 Aluminum 7514 Aluminum</p> <p>Center Mount: Center of gate and post are aligned.</p> <p>Use Gate Stop or latch to ensure gate swings away from pool.</p> <p><small>* CAUTION: When used on swimming pool gates, always consult local authorities for swimming pool Codes.</small></p>	Models	Bracket Material	75108124	Steel	75108123	Aluminum
Models	Bracket Material												
75108114	Steel												
75108113	Aluminum												
Models	Bracket Material												
75108124	Steel												
75108123	Aluminum												
<p><b>Flush Mount Brackets</b></p> <table border="1" style="width: 100%; border-collapse: collapse;"> <thead> <tr> <th>Models</th> <th>Bracket Material</th> </tr> </thead> <tbody> <tr> <td>75057214</td> <td>Steel</td> </tr> <tr> <td>75057213</td> <td>Aluminum</td> </tr> </tbody> </table> <p><b>SELF-CLOSING - NON SAFETY</b> Not suitable for child/pool safety</p> <p>Use post bracket: 7525 Steel 7515 Aluminum</p> <p>Flush Mount: Face of gate and post are aligned.</p>	Models	Bracket Material	75057214	Steel	75057213	Aluminum	<p><b>Flush Mount Brackets</b></p> <table border="1" style="width: 100%; border-collapse: collapse;"> <thead> <tr> <th>Models</th> <th>Bracket Material</th> </tr> </thead> <tbody> <tr> <td>75057224</td> <td>Steel</td> </tr> <tr> <td>75057223</td> <td>Aluminum</td> </tr> </tbody> </table> <p><b>SELF-CLOSING - SAFETY (SF Model)</b> Suitable for child/pool safety* DO NOT PROP GATE OPEN</p> <p>Use post bracket: 7525 Steel 7515 Aluminum</p> <p>Flush Mount: Face of gate and post are aligned.</p> <p><small>* CAUTION: When used on swimming pool gates, always consult local authorities for swimming pool Codes.</small></p>	Models	Bracket Material	75057224	Steel	75057223	Aluminum
Models	Bracket Material												
75057214	Steel												
75057213	Aluminum												
Models	Bracket Material												
75057224	Steel												
75057223	Aluminum												
<p><b>Center Mount Brackets</b></p> <table border="1" style="width: 100%; border-collapse: collapse;"> <thead> <tr> <th>Models</th> <th>Bracket Material</th> </tr> </thead> <tbody> <tr> <td>75057114</td> <td>Steel</td> </tr> <tr> <td>75057113</td> <td>Aluminum</td> </tr> </tbody> </table> <p><b>SELF-CLOSING - NON SAFETY</b> Not suitable for child/pool safety</p> <p>Use post bracket: 7526 Steel 7511 Aluminum 7512 Aluminum 7513 Aluminum 7514 Aluminum</p> <p>Center Mount: Center of gate and post are aligned.</p>	Models	Bracket Material	75057114	Steel	75057113	Aluminum	<p><b>Center Mount Brackets</b></p> <table border="1" style="width: 100%; border-collapse: collapse;"> <thead> <tr> <th>Models</th> <th>Bracket Material</th> </tr> </thead> <tbody> <tr> <td>75057124</td> <td>Steel</td> </tr> <tr> <td>75057123</td> <td>Aluminum</td> </tr> </tbody> </table> <p><b>SELF-CLOSING - SAFETY (SF Model)</b> Suitable for child/pool safety* DO NOT PROP GATE OPEN</p> <p>Use post bracket: 7526 Steel 7511 Aluminum 7512 Aluminum 7513 Aluminum 7514 Aluminum</p> <p>Center Mount: Center of gate and post are aligned.</p> <p>Use Gate Stop or latch to ensure gate swings away from pool.</p> <p><small>* CAUTION: When used on swimming pool gates, always consult local authorities for swimming pool Codes.</small></p>	Models	Bracket Material	75057124	Steel	75057123	Aluminum
Models	Bracket Material												
75057114	Steel												
75057113	Aluminum												
Models	Bracket Material												
75057124	Steel												
75057123	Aluminum												
<p><b>Flush Mount Brackets</b></p> <table border="1" style="width: 100%; border-collapse: collapse;"> <thead> <tr> <th>Models</th> <th>Bracket Material</th> </tr> </thead> <tbody> <tr> <td>75001214</td> <td>Steel</td> </tr> <tr> <td>75001213</td> <td>Aluminum</td> </tr> </tbody> </table> <p><b>NON SELF-CLOSING</b></p> <p>Use post bracket: 7525 Steel 7515 Aluminum</p> <p>Flush Mount: Face of gate and post are aligned.</p>	Models	Bracket Material	75001214	Steel	75001213	Aluminum	<p><b>Center Mount Brackets</b></p> <table border="1" style="width: 100%; border-collapse: collapse;"> <thead> <tr> <th>Models</th> <th>Bracket Material</th> </tr> </thead> <tbody> <tr> <td>75001114</td> <td>Steel</td> </tr> <tr> <td>75001113</td> <td>Aluminum</td> </tr> </tbody> </table> <p><b>NON SELF-CLOSING</b></p> <p>Use post bracket: 7526 Steel 7511 Aluminum 7512 Aluminum 7513 Aluminum 7514 Aluminum</p> <p>Center Mount: Center of gate and post are aligned.</p>	Models	Bracket Material	75001114	Steel	75001113	Aluminum
Models	Bracket Material												
75001214	Steel												
75001213	Aluminum												
Models	Bracket Material												
75001114	Steel												
75001113	Aluminum												

# SureClose for Aluminum Gates (Screw-on)

## Center Mount



**SM S**  
Item#: 75001113  
NON-SELF-CLOSING



**57 S**  
Item#: 75057113  
SELF-CLOSING FROM 85°  
• Holds gate open at 90°



**57SF S**  
Item#: 75057123  
SELF-CLOSING FROM 90°

**108 SF S**  
Item#: 75108123  
SELF-CLOSING FROM 90°  
• With Final Snap Action

Item#*	Type	Description	Self-Closing From	Max Gate Swing	Final Snap Action	Pool/Child Safety**	Horiz Adjust.	Hinge Gap	Fence Post Size Min.	Mount Type	Weight (Lbs)
75001113	SM S	Heavy-Duty Hinge	-	90°	-	-	Yes	2 1/2"-3" (64-76mm)	2 1/2" (64mm)	Center	1.08
75057113	57 S	Heavy-Duty Hydraulic Closer & Hinge	85°	90°	-	-	Yes	2 1/2"-3" (64-76mm)	2 1/2" (64mm)	Center	1.30
75057123	57SF S	Heavy-Duty Hydraulic Closer & Hinge	90°	90°	-	Yes	Yes	2 1/2"-3" (64-76mm)	2 1/2" (64mm)	Center	1.30
75108113	108 S	Heavy-Duty Hydraulic Closer & Hinge w/ Final Snap Action	85°	90°	Yes	-	Yes	2 1/2"-3" (64-76mm)	3" (76mm)	Center	1.80
75108123	108SF S	Heavy-Duty Hydraulic Closer & Hinge w/ Final Snap Action	90°	90°	Yes	Yes	Yes	2 1/2"-3" (64-76mm)	3" (76mm)	Center	1.80

\*Gate mounting brackets included with hinge. Post mounting brackets sold separately. Fasteners not included.  
\*\*Use only SF type closers on pool/safety gates.

## Flush Mount



**SM AT90 S**  
Item#: 75001213  
NON-SELF-CLOSING



**57 AT90 S**  
Item#: 75057213  
SELF-CLOSING FROM 85°  
• Holds gate open at 90°



**57SF AT90 S**  
Item#: 75057223  
SELF-CLOSING FROM 90°

**108 AT90 S**  
Item#: 75108213  
SELF-CLOSING FROM 85°  
• Holds gate open at 90°  
• With Final Snap Action

**108SF AT90 S**  
Item#: 75108223  
SELF-CLOSING FROM 90°  
• With Final Snap Action

Item#*	Type	Description	Self-Closing From	Max Gate Swing	Final Snap Action	Pool/Child Safety**	Horiz Adjust.	Hinge Gap	Fence Post Size Min.	Mount Type	Weight (Lbs)
75001213	SM AT90 S	Heavy-Duty Hinge	-	180°	-	-	-	1/2" (13mm)	2" (50mm)	Flush	1.17
75057213	57 AT90 S	Heavy-Duty Hydraulic Closer & Hinge	85°	180°	-	-	-	1/2" (13mm)	2" (50mm)	Flush	1.38
75057223	57SF AT90S	Heavy-Duty Hydraulic Closer & Hinge	90°	90°	-	Yes	-	1/2" (13mm)	2" (50mm)	Flush	1.38
75108213	108 AT90 S	Heavy-Duty Hydraulic Closer & Hinge w/ Final Snap Action	85°	180°	Yes	-	-	1/2" (13mm)	3" (76mm)	Flush	1.90
75108223	108SF AT90 S	Heavy-Duty Hydraulic Closer & Hinge w/ Final Snap Action	90°	90°	Yes	Yes	-	1/2" (13mm)	3" (76mm)	Flush	1.90

\*Gate mounting brackets included with hinge. Post mounting brackets sold separately. Fasteners not included.  
\*\*Use only SF type closers on pool/safety gates.

## Post Mounting Brackets

Aluminum Screw-On Options (Sold Separately)



Item#: 7511  
Center Mount



Item#: 7512  
Center Mount



Item#: 7513  
Center Mount



Item#: 7514  
Center Mount



Item#: 7515  
Flush Mount

Item#	Type	Description	Max Gate Swing	Horiz. Adjust.	Hinge Gap	Fence Post Size Min.	Mount Type	Weight (Lbs)
7511	6026-01	Aluminum	90°	Yes	2 1/2"-3" (64-76mm)	2 1/2" (64mm)	Center	0.56
7512	6026-02	Aluminum	90°	Yes	2 1/2"-3" (64-76mm)	2 1/2" (64mm)	Center	0.49
7513	6026-03	Aluminum	90°	Yes	2 1/2"-3" (64-76mm)	4" (102mm)	Center	0.64
7514	6026-04	Aluminum with Side Fixing Clamp	90°	-	2 1/2" (64mm)	2 1/2" (64mm)	Center	0.52
7515	6026-05	Aluminum	180°	-	1/2" (13mm)	2" (50mm)	Flush	0.35

# SureClose for Steel Gates (Weld-on)

## Center Mount



SM W  
Item#: 75001114  
NON-SELF-CLOSING



57 W  
Item#: 75057114  
SELF-CLOSING FROM 85°  
• Holds gate open at 90°



57SF W  
Item#: 75057124  
SELF-CLOSING FROM 90°

108SF W  
Item#: 75108124  
SELF-CLOSING FROM 90°  
• With Final Snap Action

Item#*	Type	Description	Self-Closing From	Max Gate Swing	Final Snap Action	Pool/Child Safety**	Horiz Adjust.	Hinge Gap	Fence Post Size Min.	Mount Type	Weight (Lbs)
75001114	SM W	Heavy-Duty Hinge	-	90°	-	-	Yes	2 1/2"-3" (64-76mm)	2 1/2" (64mm)	Center	1.41
75057114	57 W	Heavy-Duty Hydraulic Closer & Hinge	85°	90°	-	-	Yes	2 1/2"-3" (64-76mm)	2 1/2" (64mm)	Center	1.63
75057124	57SF W	Heavy-Duty Hydraulic Closer & Hinge	90°	90°	-	Yes	Yes	2 1/2"-3" (64-76mm)	2 1/2" (64mm)	Center	1.63
75108114	108 W	Heavy-Duty Hydraulic Closer & Hinge w/ Final Snap Action	85°	90°	Yes	-	Yes	2 1/2"-3" (64-76mm)	3" (76mm)	Center	2.14
75108124	108SF W	Heavy-Duty Hydraulic Closer & Hinge w/ Final Snap Action	90°	90°	Yes	Yes	Yes	2 1/2"-3" (64-76mm)	3" (76mm)	Center	2.14

\*Gate mounting brackets included with hinge. Post mounting brackets sold separately. Fasteners not included.  
\*\*Use only SF type closers on pool/safety gates.

## Flush Mount



SM AT90 W  
Item#: 75001214  
NON-SELF-CLOSING



57 AT90 W  
Item#: 75057214  
SELF-CLOSING FROM 85°  
• Holds gate open at 90°



57SF AT90 W  
Item#: 75057224  
SELF-CLOSING FROM 90°

108 AT90 W  
Item#: 75108214  
SELF-CLOSING FROM 85°  
• Holds gate open at 90°  
• With Final Snap Action

108SF AT90 W  
Item#: 75108224  
SELF-CLOSING FROM 90°  
• With Final Snap Action

Item#*	Type	Description	Self-Closing From	Max Gate Swing	Final Snap Action	Pool/Child Safety**	Horiz Adjust.	Hinge Gap	Fence Post Size Min.	Mount Type	Weight (Lbs)
75001214	SM AT90 W	Heavy-Duty Hinge	-	180°	-	-	-	1/2" (13mm)	2" (50mm)	Flush	1.86
75057214	57 AT90 W	Heavy-Duty Hydraulic Closer & Hinge	85°	180°	-	-	-	1/2" (13mm)	2" (50mm)	Flush	2.09
75057224	57SF AT90W	Heavy-Duty Hydraulic Closer & Hinge	90°	90°	-	Yes	-	1/2" (13mm)	2" (50mm)	Flush	2.09
75108214	108 AT90 W	Heavy-Duty Hydraulic Closer & Hinge w/ Final Snap Action	85°	180°	Yes	-	-	1/2" (13mm)	3" (76mm)	Flush	2.60
75108224	108SF AT90 W	Heavy-Duty Hydraulic Closer & Hinge w/ Final Snap Action	90°	90°	Yes	Yes	-	1/2" (13mm)	3" (76mm)	Flush	2.60

\*Gate mounting brackets included with hinge. Post mounting brackets sold separately. Fasteners not included.  
\*\*Use only SF type closers on pool/safety gates.

## Post Mounting Brackets

Steel Weld-on Options (Sold Separately)



Item#: 7525  
Flush Mount



Item#: 7526  
Center Mount

Pool and child safety gate models (SF type) can be identified by the fifth dimple on the end cap.

DO NOT use any non-SF models (4-dimples only) on gates where human safety is critical.



Item#	Type	Description	Max Gate Swing	Horiz. Adjust.	Hinge Gap	Fence Post Size Min.	Mount Type	Weight (Lbs)
7525	0510-04	Steel	180°	-	1/2" (13mm)	2 1/2" (64mm)	Flush	0.35
7526	0510-05	Steel	90°	Yes	2 1/2"-3" (64-76mm)	2 1/2" (64mm)	Center	1.08

### ReadyFit 108

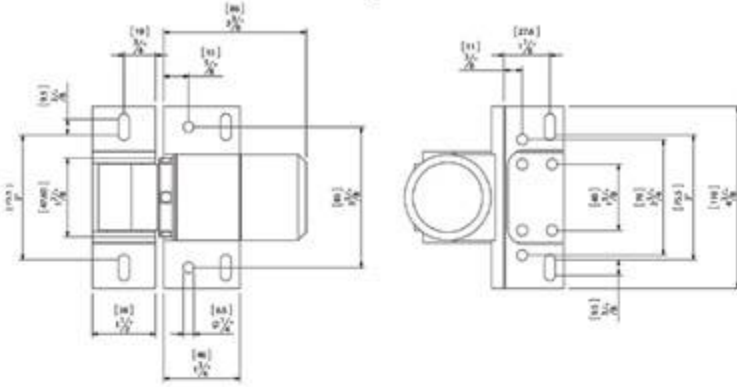

### ReadyFit SM

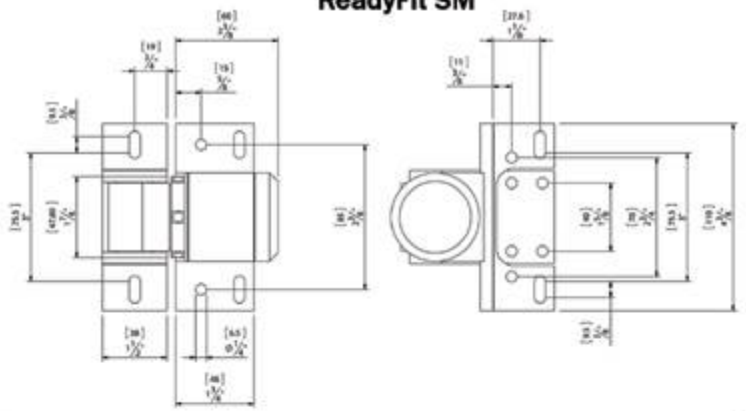

### 108 AT90 S & 108SF AT90 S

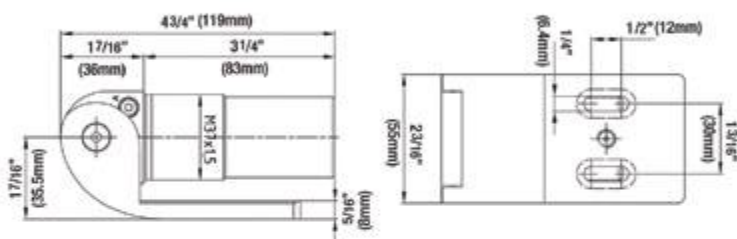

### SM AT90 S

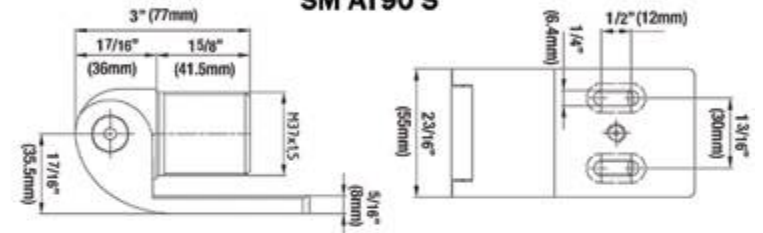

### 57 AT90 S & 57SF AT90 S

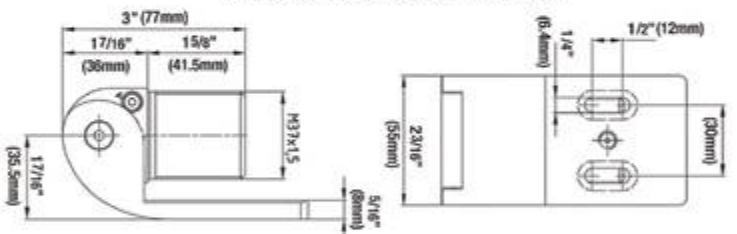

### SM S

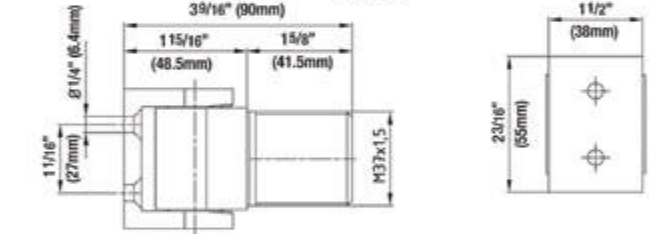

Flush Mount models require 1 9/16" (40mm) hole in fence post.

### 57S & 57SF S

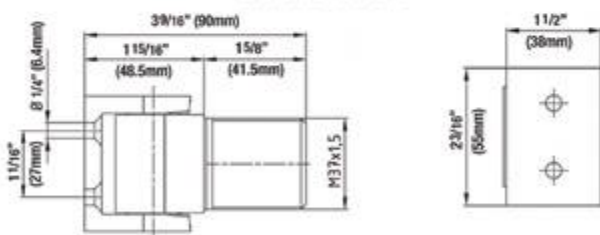

### 108S & 108SF S

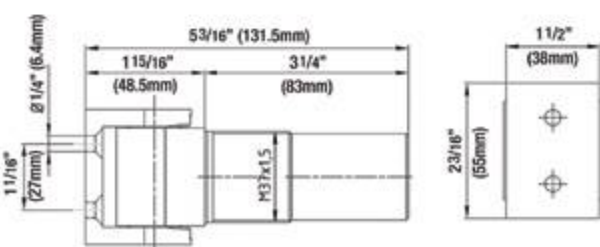

Center Mount models require 1 7/8" (48mm) hole in fence post.

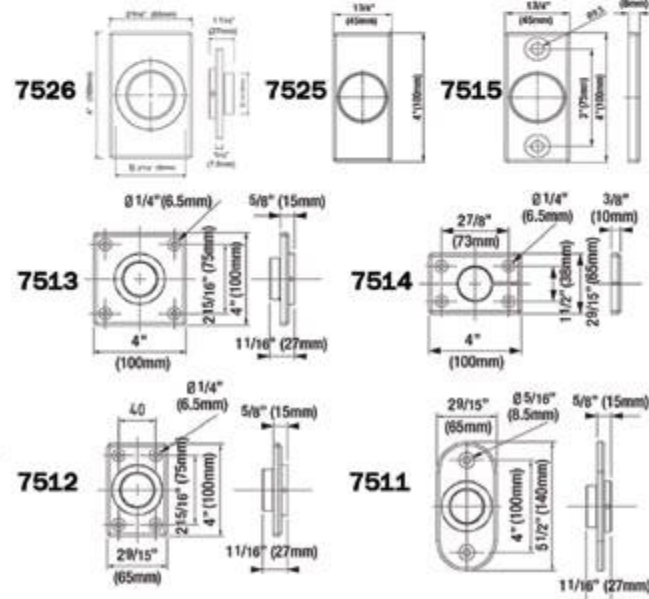

Please visit our website for a complete product overview, including video animations, installation instructions, CAD & Spec.